

# **Bushnell<sup>®</sup>**

## **TRAIL CAMERAS**



### **CELLUCORE 20 DUAL SIM TRAIL CAMERA INSTRUCTION MANUAL**

CELLUCORE 20 DUAL SIM MODEL # 119904D



## **WELCOME**

Welcome to your Bushnell Trail Camera! This manual has all the instructions you need to set up your camera and your account, plus quick answers to your questions.

If your camera does not seem to be functioning properly or if you are having image quality issues, please check the Troubleshooting Tips section.

If your problem continues after trying the solutions in Troubleshooting Tips, please call Bushnell Customer Service at (800) 423-3537. In Canada, call (800) 361-5702.

Note: This Bushnell trail camera model is not designed or intended for operation or sale outside of the United States.

## **TABLE OF CONTENTS**

Camera Overview	4
Camera Status Indicator Guide	6
Quick Start Guide	6
Settings Menu	10
Mounting & Positioning	12
Frequently Asked Questions	15
Technical Specifications	17
Two-Year Limited Warranty	18

## CAMERA OVERVIEW

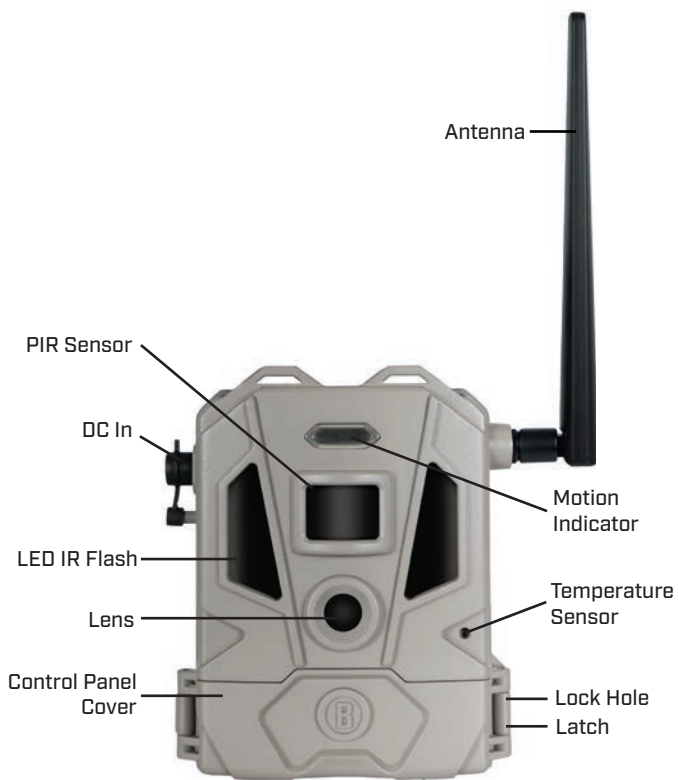

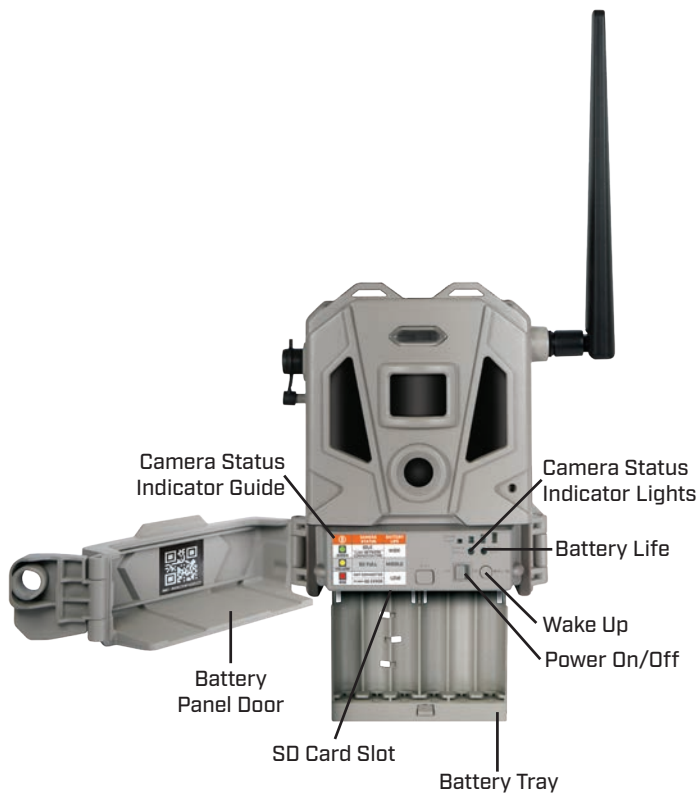

## CAMERA STATUS INDICATOR GUIDE

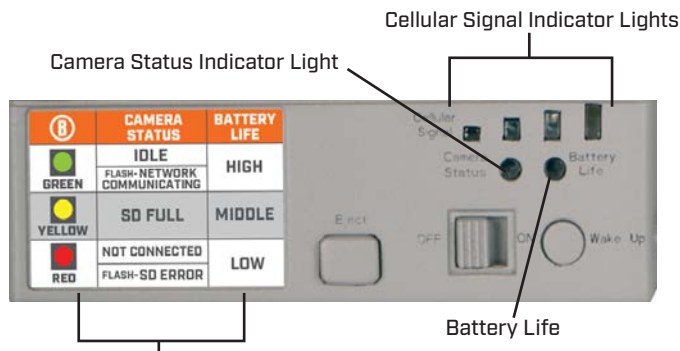

Look here to identify what a green, yellow, or red light means for your camera status and battery life.

## QUICK START GUIDE



**1.** Download the free Bushnell Trail Camera app on your smartphone from the App Store (iPhone®) or Google Play® (Android®).

**2.** Open the app, then sign in or create a new account.



**3.** Log in and click the Camera icon at the bottom of the screen, then click “+” to add a new camera. Scan the QR code on the label inside your camera again or manually enter its serial # to associate this camera with your account.



**4.** Install 12 AA batteries (Energizer® lithium batteries are recommended. Alkaline batteries may be used but battery life will be shorter. Rechargeable batteries are not recommended). Be sure to position the batteries for correct polarity (+/-) when installing.

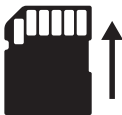

**5.** Install a new SD card, up to 32GB. High speed cards (class 10 or higher) are recommended if you plan to record video clips.

**6.** Your CelluCORE 20 Dual Sim is equipped with a dual SIM modem. The camera will automatically connect to the carrier with the strongest service (ATT or Verizon) each time the camera is powered on. If you want to ensure you have the strongest signal in a given area, simply power the camera off and power it back on. This will ensure you have maximum signal

strength. **[We recommend using your camera in a location that gives you minimally two bars of signal strength. Lower signal strength can cause interruptions in service and shorten battery life.]**

**7.** Your Cellucore 20 Dual Sim comes equipped with a detachable solar panel. Removing and repositioning the panel allows you to achieve maximum sunlight and solar charging regardless of where the camera lens is pointed. To reposition your panel, remove the thumb screw from the back of the solar panel and mount the panel in another location using a 1/4x20 mounting bracket (not included). (Hint: replace the thumb screw so that you do not misplace it.) Connect the panel to the camera with the included alternate power supply cable. (This cable is only needed when the solar panel is detached from the camera)

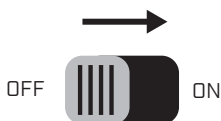

**8.** At the location where you will place the camera, move the power switch to the On position. The camera's default settings were chosen for typical usage as a scouting camera for hunters: photo mode at 2MP resolution, with a 10 second interval between photos, and "Medium" LED flash power



output. These settings may be easily changed to suit your individual preferences or application (for example, if you would rather capture videos, or photos at a different resolution, spaced further apart), using the app on your smartphone or home computer.

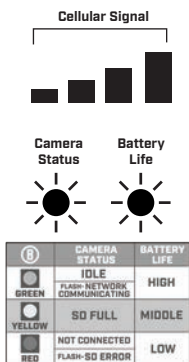

(see pg. 6 for camera status indicator guide)

**9.** Prior to closing the camera, ensure the camera has acquired cellular signal and is operating properly by checking the camera status indicator lights and guide. Lower signal strength can cause interruptions in service and shorten battery life.

Mount the camera to a tree or post using the provided tree strap or 1/4"-20 mounting socket.

Your wireless camera is now ready to use. You can now utilize the mobile application or management website to review images, change camera settings, monitor battery life and manage your account.

*Android® and Google Play® are registered trademarks of Google Inc. iPhone® is a registered trademark of Apple, Inc.*

## **SETTINGS MENU** *[Check your app for these settings]*

**CAMERA MODE** - Selects type of image files that are stored/transmitted [note: see “Hybrid” under Video submenu].

**IMAGE** - Still images will be captured by the camera at settings made in the PHOTO menu.

**MOVIE** - Video clips will be captured at settings made in the VIDEO menu. NOTE: your full HD video files will be stored on the SD card, but they cannot be transmitted wirelessly due to the file size/cell carrier bandwidth.

**HYBRID**- Captures a single image followed by a video clip.

**IMAGE RESOLUTION** - Selects resolution [in megapixels] for still photos. Higher resolution provides more pixels for increased detail, but creates larger files that take up more of the SD card capacity [fills up faster]. Available settings are: Low, medium and high. Low is the default setting, which will deliver excellent detail while still keeping the file size per image reasonable for most users.

**CAPTURES PER TRIGGER**- Selects the number of photos captured per trigger event, with settings from 1 to 5 [default is 1 photo per trigger].

**VIDEO RESOLUTION** - Selects resolution for video clips. Choice of 1280x720 [720p], or 960x544 [544p].

**VIDEO LENGTH** - Selects duration of each video clip captured per trigger. The default setting is 5S [five seconds per video]. From the 10 SEC setting up, length settings are in 5 second increments. Maximum video length is 20 Seconds.

**CAMERA NAME** - Allows you to enter up to 12 characters

of your choice to identify this camera. Especially useful for multi-camera setups. This will be imprinted on each photo. Default name is “CORE CAM”.

**PIR DELAY** - Selects the length of time that the camera will ignore additional triggers from the PIR after an animal is first detected and remains within the sensor’s range. During this user set interval, the camera will not capture photos or videos. For example, if a second trigger event occurs 7 seconds after the first, but the delay time is set to 10 seconds, the second trigger will be ignored and a new image will not be captured until the 10 seconds has elapsed. Only the next trigger that occurs after 10 seconds will take a new photo/video, and so on. This prevents the card from filling up with too many redundant images. The default setting is 10 SEC (a ten second delay). From the 10 SEC setting up, delay settings are in 5 second increments. After scrolling past “59 SEC”, settings go from “1 MIN” to “10 MIN” and then progress to 60 MIN at five-minute increments (15 MIN, 20MIN, etc.).

**WORK MODE** - Determines when the PIR (passive infrared) sensor will activate the camera and capture images.

**DAY** - 6:00 A.M. - 6:00 P.M.

**NIGHT** - 6:00 P.M. - 6:00 A.M.

**24HRS** - PIR Sensor triggers 24 hours a day.

### Flash Mode:

**SHORT RANGE** - This is Medium LED output and fast shutter speed that is designed to capture good images of animals up close. This setting will provide the longest battery life but the shortest flash range.

**FAST MOTION** – This setting has maximum flash output and fast shutter speed. It will provide the sharpest images and medium flash range and battery life.

**LONG RANGE** – This setting has High LED output and Slow shutter speed and provides maximum flash range but the least battery life. You will also see more “motion blur” if the objects are moving quickly at night.

**TIMESTAMP** - The date and time will be set once the camera has connected to the server and will be imprinted on all images.

**WIRELESS** - Sets cellular signal transmission to ON (default) or OFF.

### **Communication Frequency:**

**IMMEDIATELY** - Images will be transmitted immediately after they are captured and saved to the SD card.

**DAILY** - All new images will be transmitted only once daily.

**WEEKLY** – All new images will be transmitted once per week. [This setting will give you the best battery life].

## **MOUNTING & POSITIONING**

After you've set up the camera's settings to your preferences, you're ready start capturing images.

We recommend mounting the camera on a sturdy tree or post with a diameter of about 6 in. To get the optimal picture quality, the camera should be about 16-17 ft. away from the

place to be monitored, with the camera placed at a height of 3.5-5 ft. Also, keep in mind that you will get the best results at night when the subject is within the ideal flash range, no farther than 60' and no closer than 10' from the camera.

The height away from the ground for placing the device should vary with the animal size appropriately. In general, 3 to 6 feet is preferred. You can avoid potential false triggers due to temperature and motion disturbances in front of the camera by not aiming it at a heat source or nearby tree branches or brush (especially on windy days).

### **There are two ways to mount the camera:**

- **Using the provided adjustable belt:** Push one end of the belt through the two slots on the back of the trail camera. Thread the end of the strap through the buckle. Fasten the belt securely around the tree trunk by pulling the end of the strap firmly so there is no slack left.

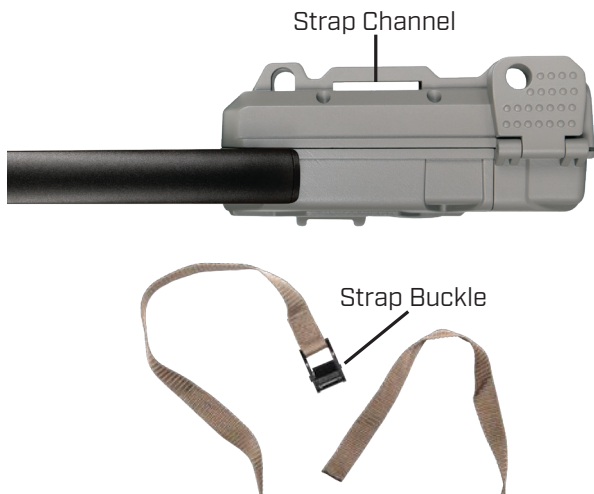

- **Using the tripod socket:** The camera is equipped with a socket at the back (below the strap brackets) to enable mounting on a tripod or other camera mounting accessories that have a standard 1/4"-20 thread.



## **FREQUENTLY ASKED QUESTIONS**

*For quick help with more questions, call Customer Service at (800) 423-3537. In Canada, call (800) 361-5702.*

### **1. CELLULAR SIGNAL STRENGTH**

#### **Q: How do I make sure my camera is connected to the best network in my area?**

*Your Cellucore 20 Dual Sim checks in with both ATT and Verizon networks each time it is booted up and selects the strongest signal for connection. **[We recommend using your camera in a location that gives you minimally two bars of signal strength. Lower signal strength can cause interruptions in service and shorten battery life.]***

### **DATA & DATA PLANS**

#### **Q: If I have multiple cameras do I need a data plan for each camera?**

*Yes, each camera must have an active data plan to transmit images.*

#### **Q: How do I cancel or suspend my data plan?**

*You can Cancel or Suspend your data plan through the wireless application in the “Camera” tab or through the management website.*

### **PHOTOS**

#### **Q: Can I transmit photos to more than one cell phone number or email address?**

*Accounts are tied to a customer’s e-mail address. You can have multiple devices logged into the same account but only one e-mail address per account. If you wish to share your photos with others you will need to share the account log in information with them.*

**Q: How do I delete photos on my account?**

*There are several ways to delete images. From the tile view screen you can hold down on the image and it will select the image (place a check next to it). Once it is selected you can click the Trash Can icon to delete it. You can also delete the image from the individual image view by clicking the Trash Can icon.*

**VIDEOS****Q: How do I access the videos from the camera?**

*If there is a video captured by the camera it will be saved to the SD card. To access the video you must retrieve it from the SD card and insert into a computer or SD reader where the video can be reviewed.*

**SD CARDS****Q: What size and brand SD card?**

*We recommend SanDisk Class 10 up to 32GB*



## **TECHNICAL SPECIFICATIONS**

**Lens:** F = 2.3; FOV=47°; Auto IR-Cut-Remove (at night)

**Picture Size** [pixel count in 16:9 format]: 2MP=1920x1080, 8MP=3840x2160, 20MP=5888x3312

**Video Size:** 1280x720P or 960x544 [544p] @ 15-30 fps

**Video Length:** Fixed length video time settings range from 5 to 20 seconds

**PIR Sensitivity:** 4 settings: Low/Normal/High/Auto

**Response Time:** 1 second (Photo), 2.5 second (Video). 2.5 second interval

**Triggering Interval:** 5 sec. - 60 min. programmable

**Images per Trigger:** 1–5 programmable

**Power Supply:** 12x AA batteries, lithium (recommended) or alkaline.

**Stand-by Current:** < 200uA

**Average Battery Life:** Approx. 6 mos. at 20 images per day average (10 day, 10 night w/LEDs)

**Operating Temperature:** -10 - 50°C (Storage temperature: -20 - 60°C)

**Operating Humidity:** 5% - 90%

**DC In (Camera DC port):** 9V/2A

**⚠ WARNING:** This product can use Lithium based batteries. Lithium batteries can overheat and cause damage if physically abused. Do not use any batteries that are damaged or show signs of physical wear. Never use a mix of old and new batteries, or batteries with different brand names.

## **TWO-YEAR LIMITED WARRANTY**

Your Bushnell® product is warranted to be free of defects in materials and workmanship for two years after the date of purchase. In the event of a defect under this warranty, we will, at our option, repair or replace the product, provided that you return the product postage prepaid. This warranty does not cover damages caused by misuse, improper handling, installation, or maintenance provided by someone other than a Bushnell Authorized Service Department.

Any return made under this warranty must be accompanied by the items listed below:

- A check/money order in the amount of \$10.00 to cover the cost of postage and handling.
- Name, address and daytime phone # for product return.
- An explanation of the defect.
- Copy of your dated proof of purchase.
- Do not send in accessories (batteries, SD cards, strap), only the product for repair.

Product should be well packed in a sturdy outside shipping carton to prevent damage in transit, and shipped to the address listed below:

### **IN U.S.A. Send To:**

Bushnell Outdoor Products  
Attn: Repairs  
9200 Cody  
Overland Park, Kansas 66214

**IN CANADA Send To:**

Bushnell Outdoor Products  
Attn.: Repairs  
140 Great Gulf Drive, Unit # B  
Vaughan, Ontario L4K 5W1

For products purchased outside the United States or Canada please contact your local dealer for applicable warranty information.

This warranty gives you specific legal rights.  
You may have other rights which vary from country to country.  
©2022 Bushnell Outdoor Products

Specifications and designs are subject to change without any notice or obligation on the part of the manufacturer.

**FCC COMPLIANCE STATEMENT**

This device complies with part 15 of the FCC Rules. Operation is subject to the following two conditions: (1) This device may not cause harmful interference, and (2) this device must accept any interference received, including interference that may cause undesired operation.

This equipment has been tested and found to comply with the limits for a Class B digital device, pursuant to Part 15 of the FCC Rules. These limits are designed to provide reasonable protection against harmful interference in a residential installation. This equipment generates, uses and can radiate radio frequency energy and, if not installed and used in accordance with the instructions, may cause harmful interference to radio communications. However, there is no guarantee that interference will not occur in a particular

installation. If this equipment does cause harmful interference to radio or television reception, which can be determined by turning the equipment off and on, the user is encouraged to try to correct the interference by one or more of the following measures:

- Reorient or relocate the receiving antenna.
- Increase the separation between the equipment and receiver.
- Connect the equipment into an outlet on a circuit different from that to which the receiver is connected.
- Consult the dealer or an experienced radio/TV technician for help.

Shielded interface cable must be used with the equipment in order to comply with the limits for a digital device pursuant to Subpart B of Part 15 of FCC Rules. Specifications and designs are subject to change without any notice or obligation on the part of the manufacturer.

**Contains FCC ID: XMR2020BG95M2** 

**Note: This Bushnell Wireless Camera is not designed or intended for operation or sale outside of North America.**

This product features technology licensed from Zipit Wireless, Inc. (“Zipit”), that is copyrighted work of, and may be patented by, Zipit Wireless, Inc. Copyright 2003-2020 Zipit Wireless, Inc. All rights reserved. Access to the Zipit services may be bound by EULA and Privacy policies located at [www.bushnell.com](http://www.bushnell.com) or [www.zipitwireless.com/legal](http://www.zipitwireless.com/legal).

**⚠ CAUTION :**

**RISK OF EXPLOSION IF BATTERY IS REPLACED BY AN INCORRECT TYPE.**

**DISPOSE OF USED BATTERIES ACCORDING TO THE INSTRUCTIONS:**

Do not disposal of a battery into fire or a hot oven, or

mechanically crushing or cutting of a battery, that can result in an explosion;

Do not leaving a battery in an extremely high temperature surrounding environment that can result in an explosion or the leakage of flammable liquid or gas.

Do not expose the battery to extremely low air pressure that may result in an explosion or the leakage of flammable liquid or gas.

**FOR END USER LICENSE AGREEMENT AND TERMS/  
CONDITIONS OF USE,  
PLEASE VISIT [WWW.WIRELESSTROPHYCAM.COM](http://WWW.WIRELESSTROPHYCAM.COM)**

*iPhone® is a registered trademark of Apple Inc.*

*Android™ and Google Earth are trademarks of Google Inc.*

*AT&T® is a registered trademark of AT&T Inc.*

*Verizon™ and Verizon Wireless™ are trademarks of*

*Verizon Trademark Services, LLC*

**DISPOSAL OF ELECTRIC AND ELECTRONIC EQUIPMENT**

[Applicable in the EU and other European countries with separate collection systems]

*This equipment contains electric and/or electronic parts and must therefore not be disposed of as normal household waste. Instead, it should be disposed at the respective collection points for recycling provided by the communities. For you, this is free of charge. If the equipment contains exchangeable [rechargeable] batteries, these too must be removed before and, if necessary, in turn be disposed of according to the relevant regulations (see also the respective comments in this unit's instructions). Further information about the subject is available at your community administration, your local waste collection company, or in the store where you purchased this equipment.*



# **Bushnell®**

## **TRAIL CAMERAS**

For further questions or additional information please contact:

Bushnell Outdoor Products  
9200 Cody, Overland Park, Kansas 66214

(800) 423-3537 | [www.bushnell.com](http://www.bushnell.com)

©2022 Bushnell Outdoor Products